

# CRYSTALLOGRAPHIC TEXTURE IN A FRICTION STIR PROCESSED CAST ALSI9MG ALUMINUM ALLOY

M. Wróbel<sup>1</sup>, D. Nikolayev<sup>2</sup>, T. Lychagina<sup>2</sup>, M. Kopyściński<sup>1</sup>, S. Dymek<sup>1</sup>, M.S. Węglowski<sup>3</sup>, Z. Sekretarev<sup>2</sup>, A. Baczmański<sup>1</sup>  
<sup>1</sup> AGH University of Science and Technology, 30 Av. Mickiewicza, 30-059 Kraków, Poland  
<sup>2</sup> Joint Institute for Nuclear Research, Joliot-Curie, 6, 141980, Dubna, Russia  
<sup>3</sup> Łukasiewicz Research Network – Welding Institute, Błogosławionego Czesława Str. 16-18, 44-100 Gliwice, Poland

## ABSTRACT

The global and local texture (GT and LT, respectively) development resulted from severe plastic deformation occurring during friction stir processing (FSP) of an AlSi9Mg alloy was investigated. The AlSi9Mg alloy is composed of two phases: Al solid solution and Si crystals. The multiple-pass FSP with 75% overlap between the successive passes was applied. The GT of both phases was measured by neutron diffraction on the SKAT diffractometer operating at the beam line 7 in the Joint Institute for Nuclear Research, Dubna, Russia. The LT, as well as microstructural studies, were performed in the AGH University in Kraków, Poland. The LT was measured both by the X-ray diffraction and by the Electron Backscatter Diffraction (EBSD) in a Scanning Electron Microscope.

## EXPERIMENTAL

### Friction stir processing

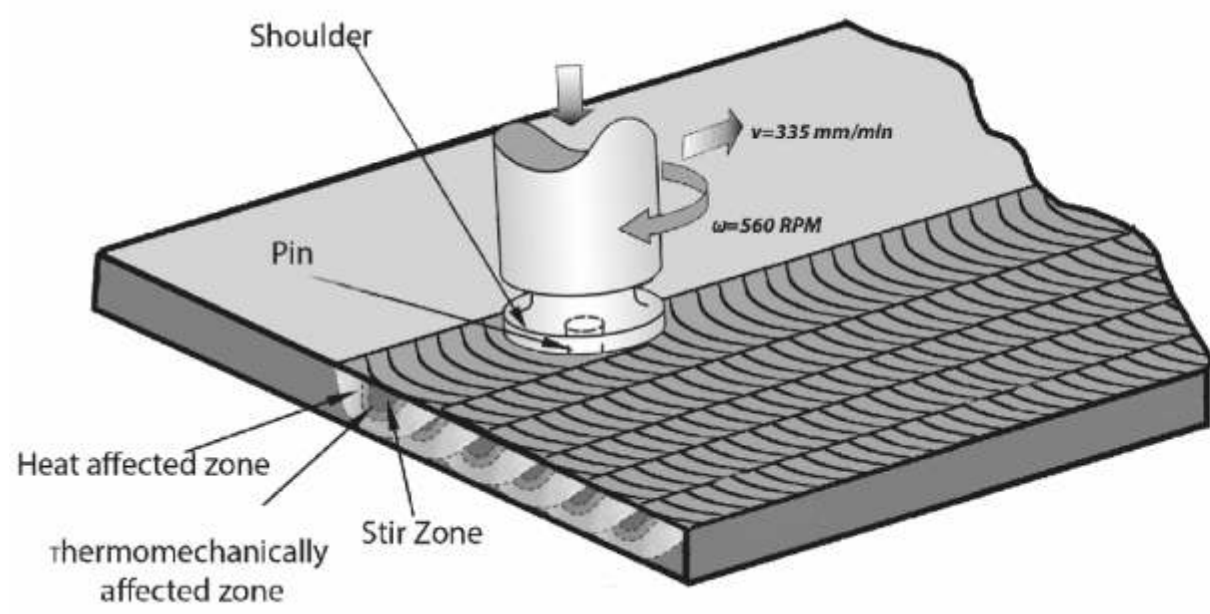

### Neutron (SKAT) diffractometer in the JINR, Dubna, Russia

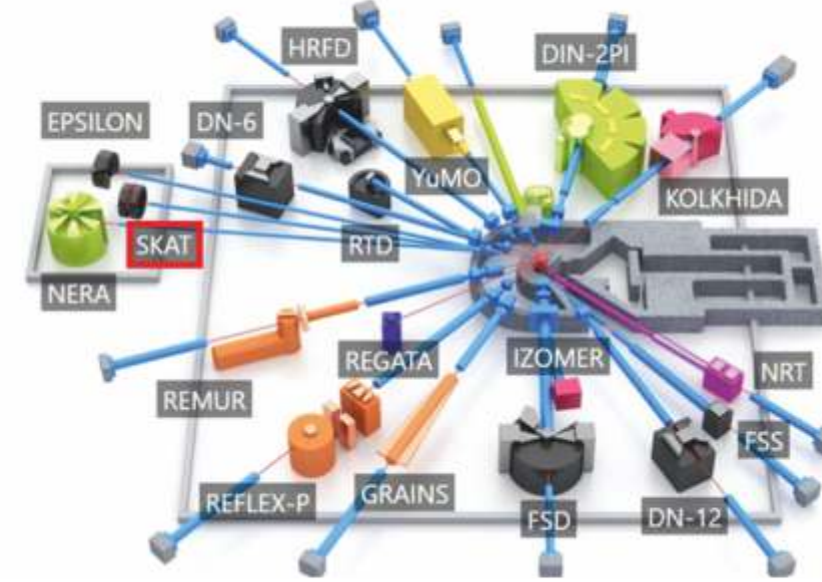

## RESULTS

### Microstructure of base material

#### SEM-BSE

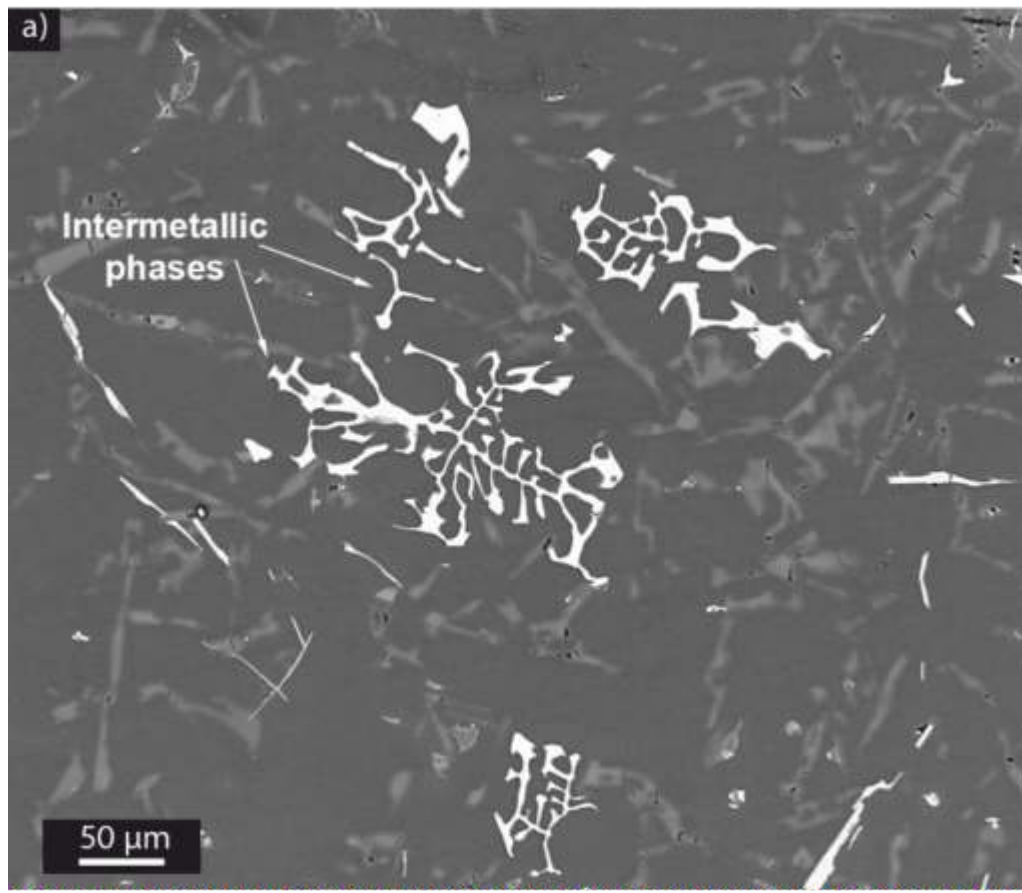

#### SEM-BSE

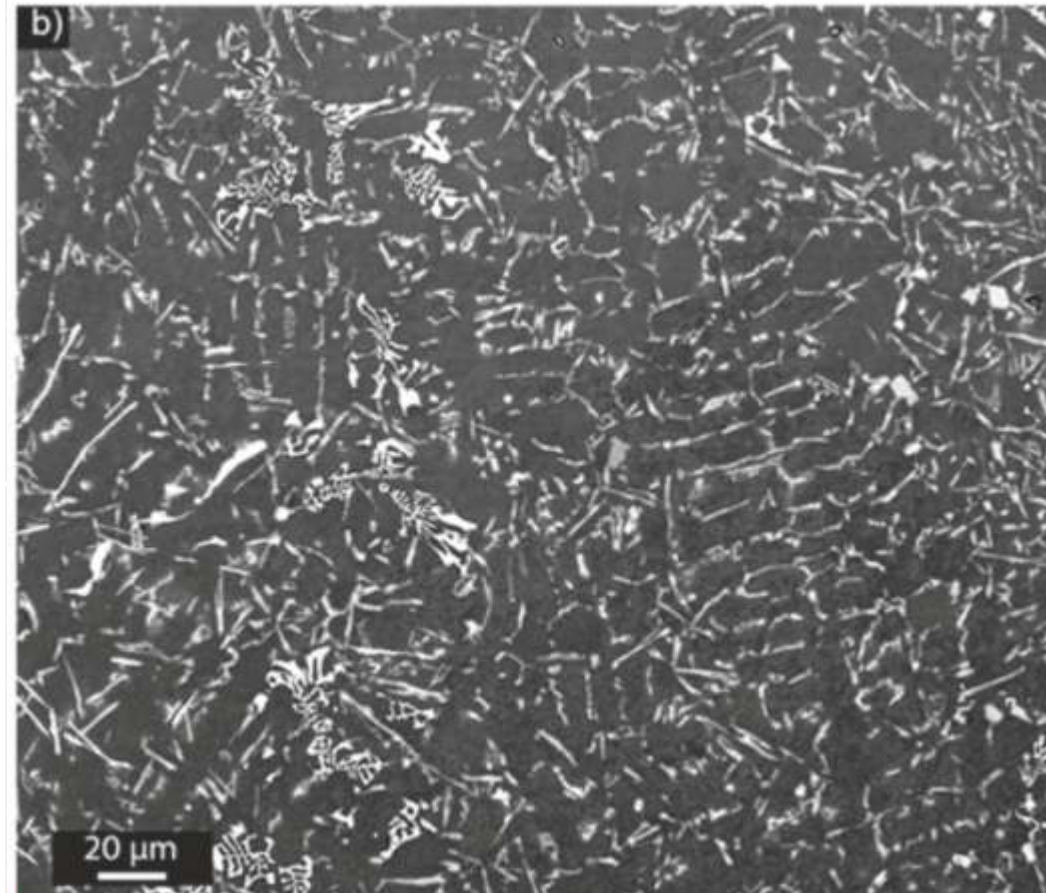

### Texture of base material

#### XRD

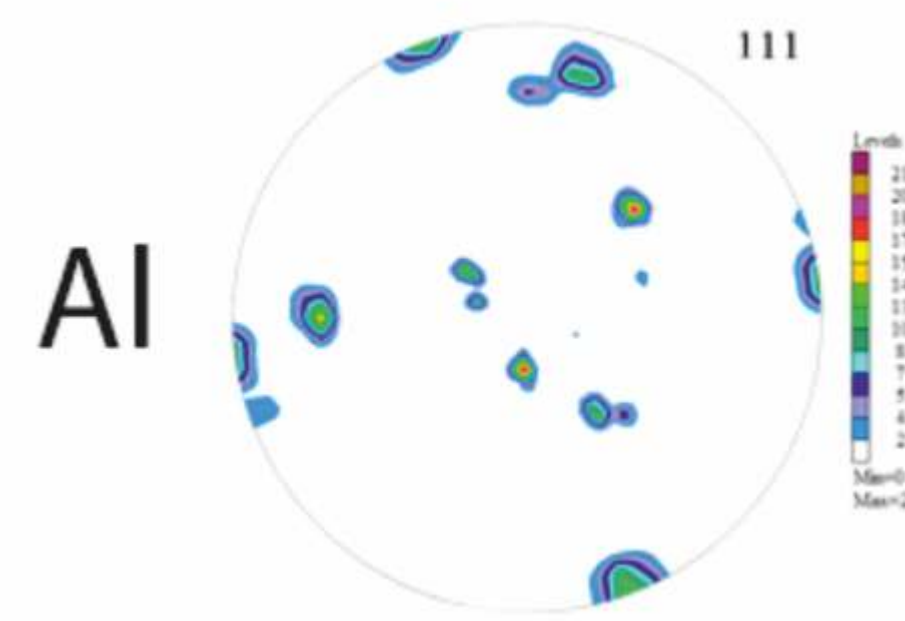

#### Neutron

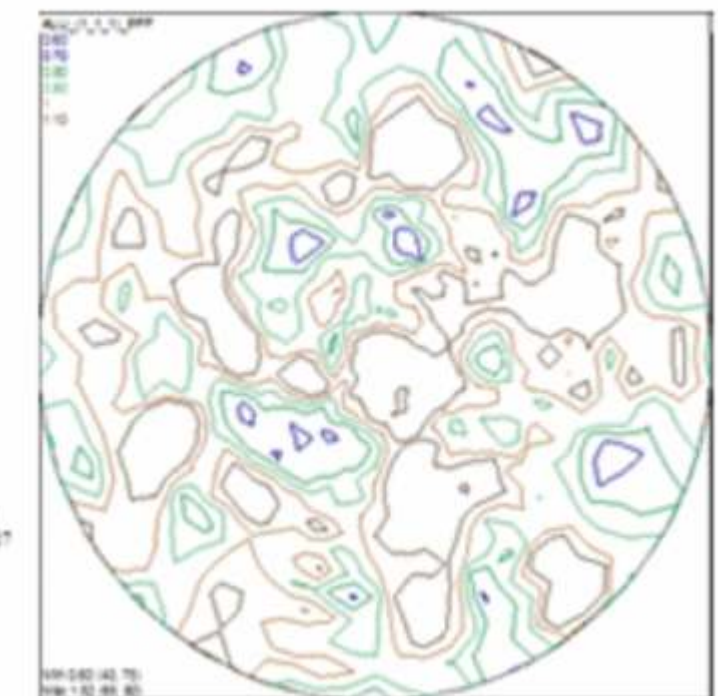

### Microstructure of as-processed material

#### SEM-BSE

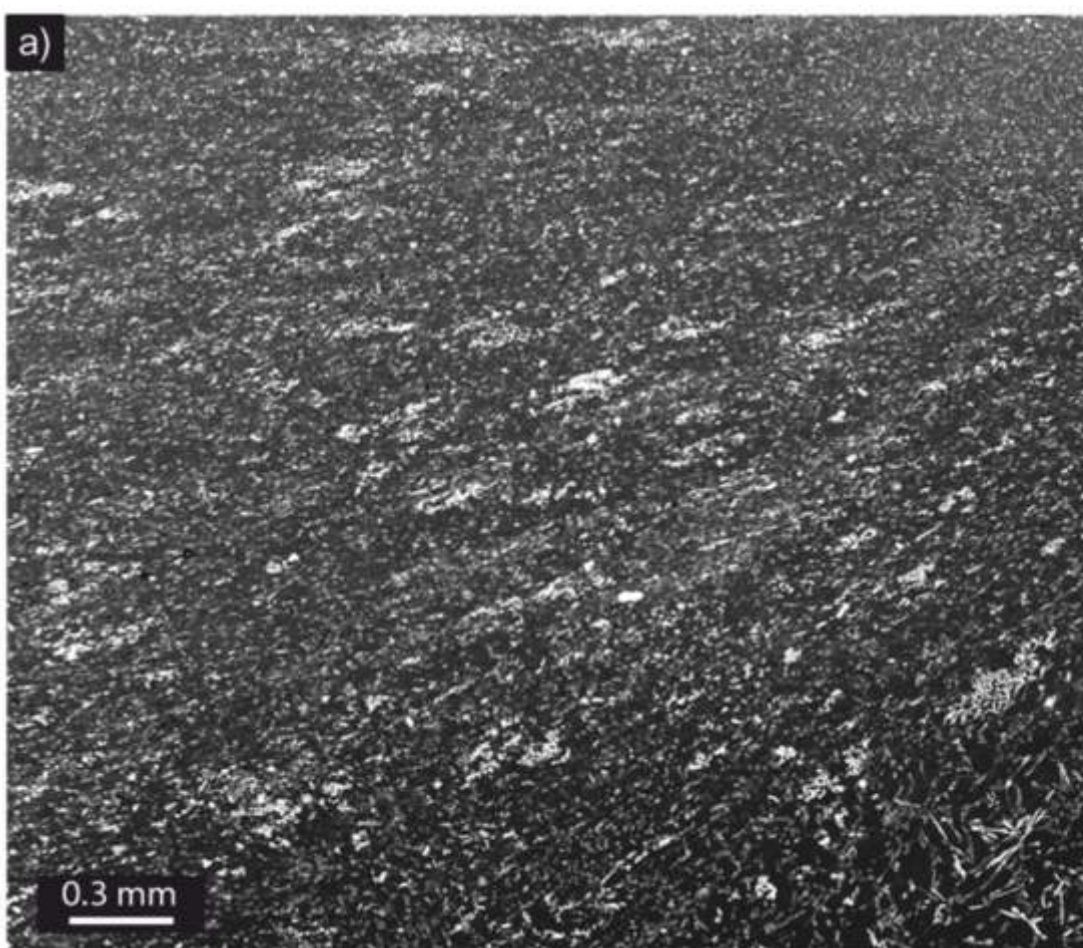

#### SEM-EBSD

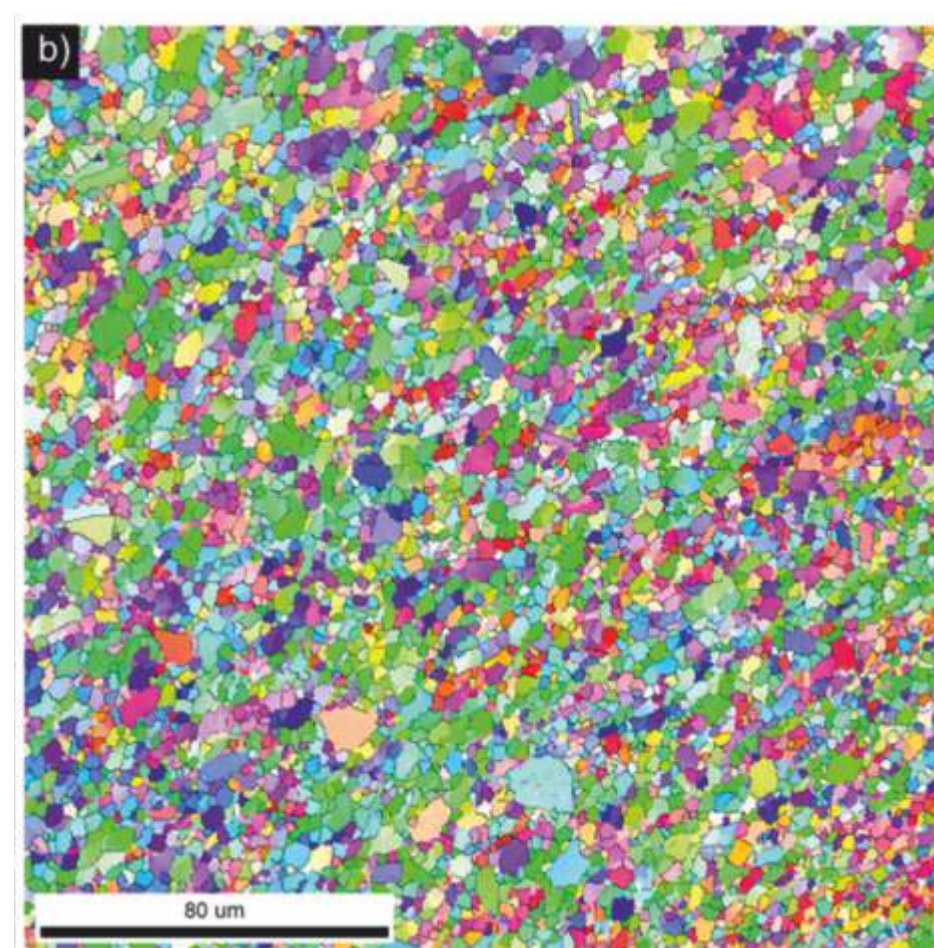

### Texture of as-processed material

#### XRD

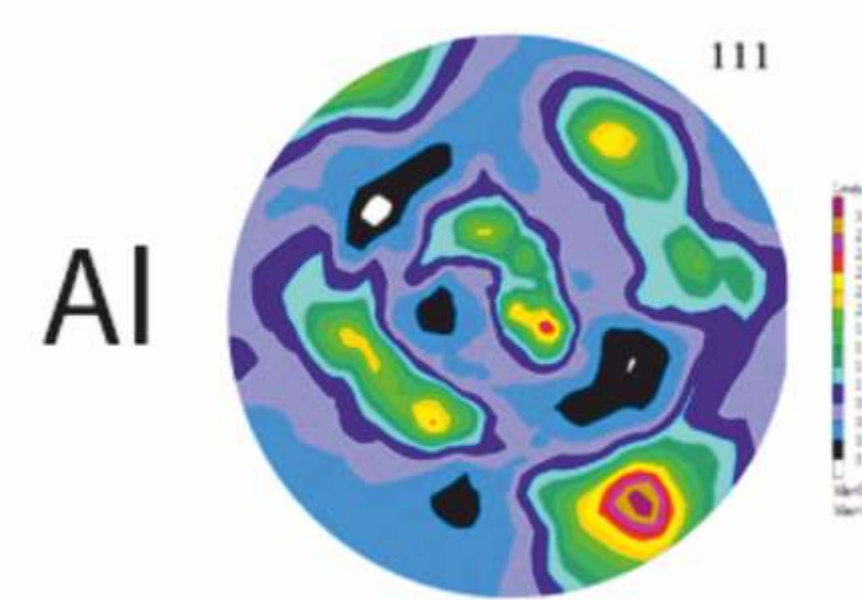

#### Neutron

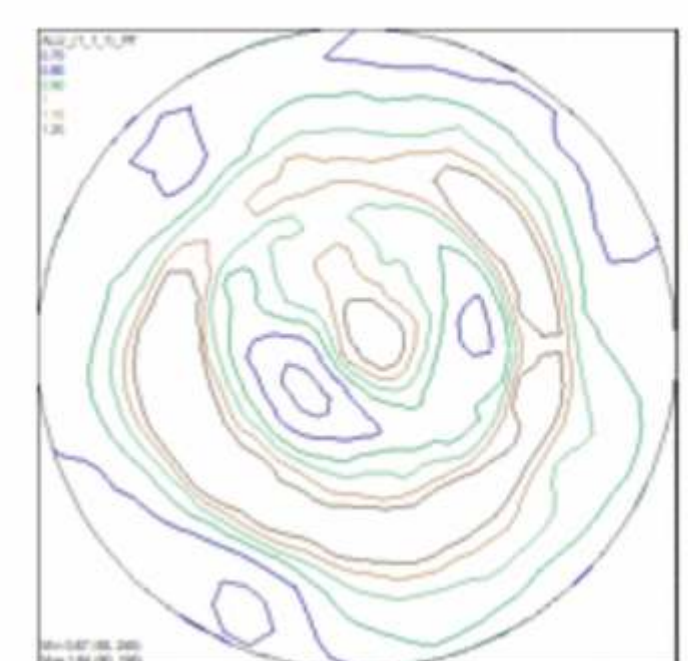

#### TEM

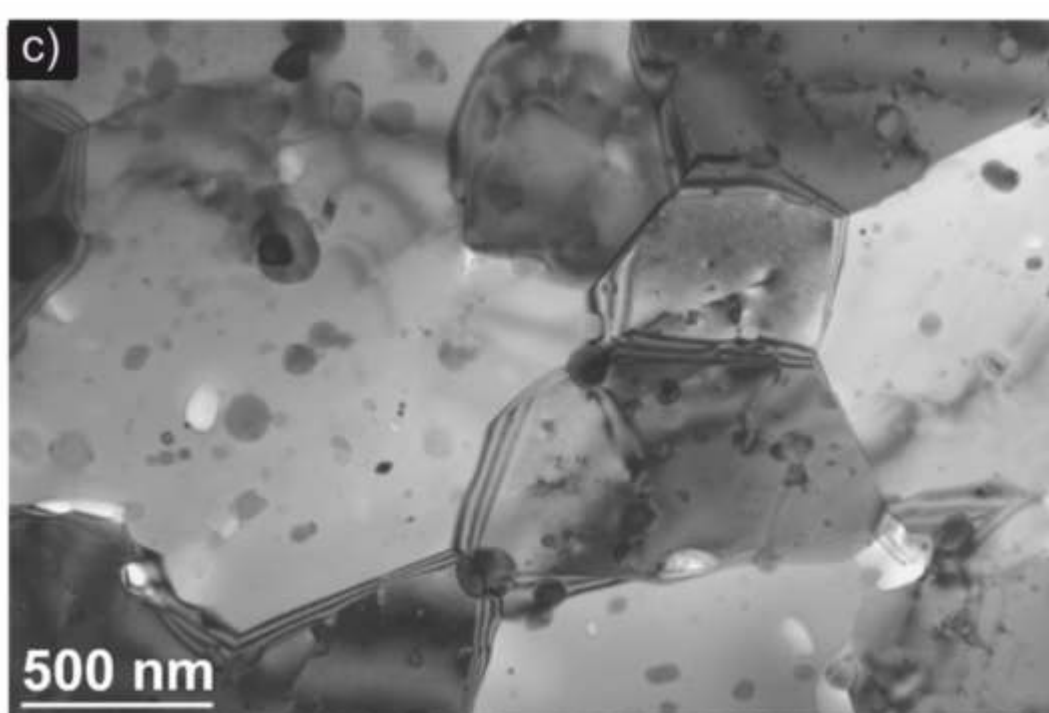

#### TEM

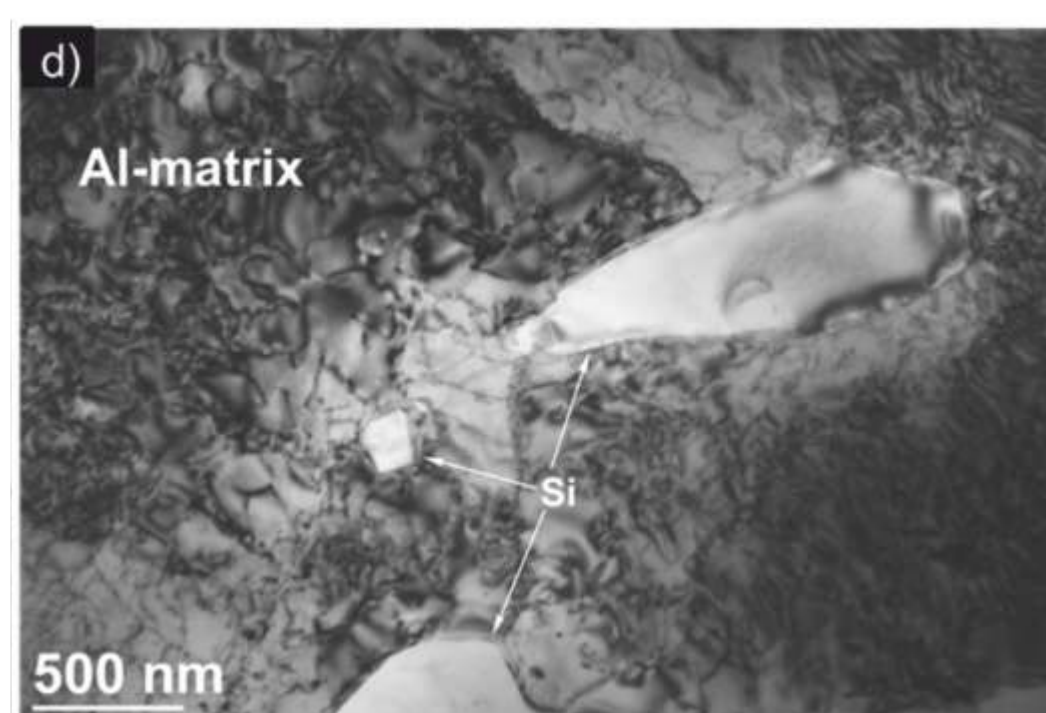

#### XRD

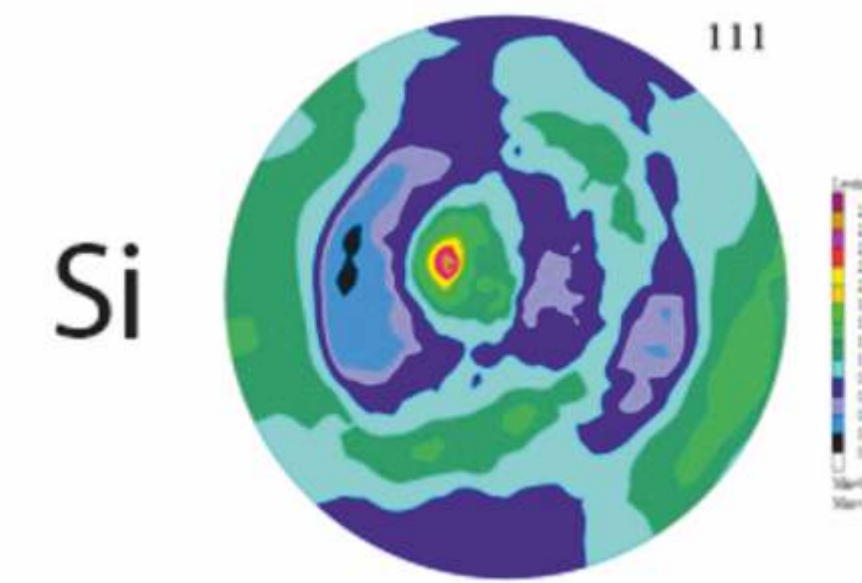

#### Neutron

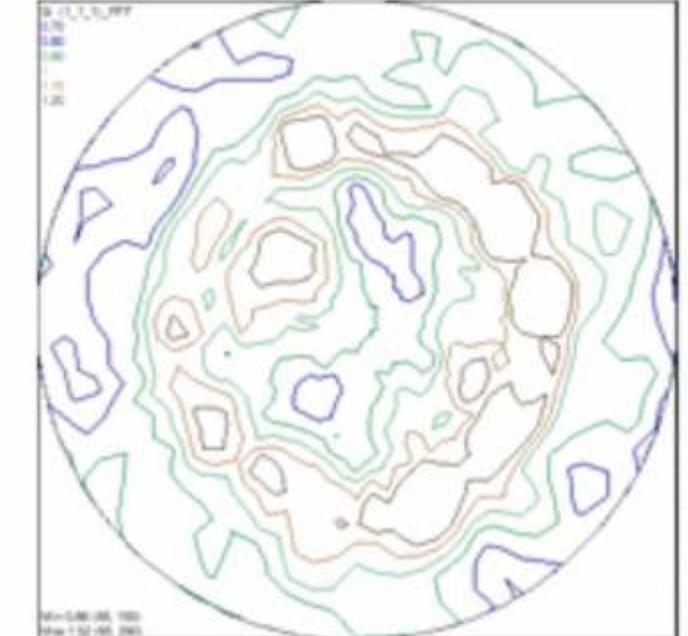

Marek St. Węglowski Ph.D., Eng.  
 Łukasiewicz – Institute of Welding  
 Bl. Czesława Str. 16-18  
 tel. +48 32 33 58 236  
 44-100 Gliwice  
 Marek.Weglowski@is.gliwice.pl

### Summary

It has been found that the typical dendrite solidification microstructure was significantly refined due to FSP. The material porosity, typical for cast alloys, was nearly completely eliminated. The heavy plastic deformation produced changes in crystallographic texture not only in the matrix but also in Si particles. The developed textures were mutually symmetrical and slightly different in intensity. It was shown that overall GT and LT are compatible with each other. The neutron diffraction made it possible to measure changes in crystallographic orientation of Si particles. This is the main advantage of neutron diffraction.

### Acknowledgements

The Joint Institute for Nuclear Research (JINR) – Poland Scientific Program 2019-2020 is greatly acknowledged.



**62.**

**MIĘDZYNARODOWA  
KONFERENCJA  
SPAWALNICZA**

Nowoczesne spawalnictwo  
– nowoczesna przyszłość



INTERNATIONAL CONGRESS  
 Konferencji towarzyszy  
 Kongres Międzynarodowego  
 Instytutu Spawalnictwa (IIW)

